

BARN WALL, PARTITION OR FENCE

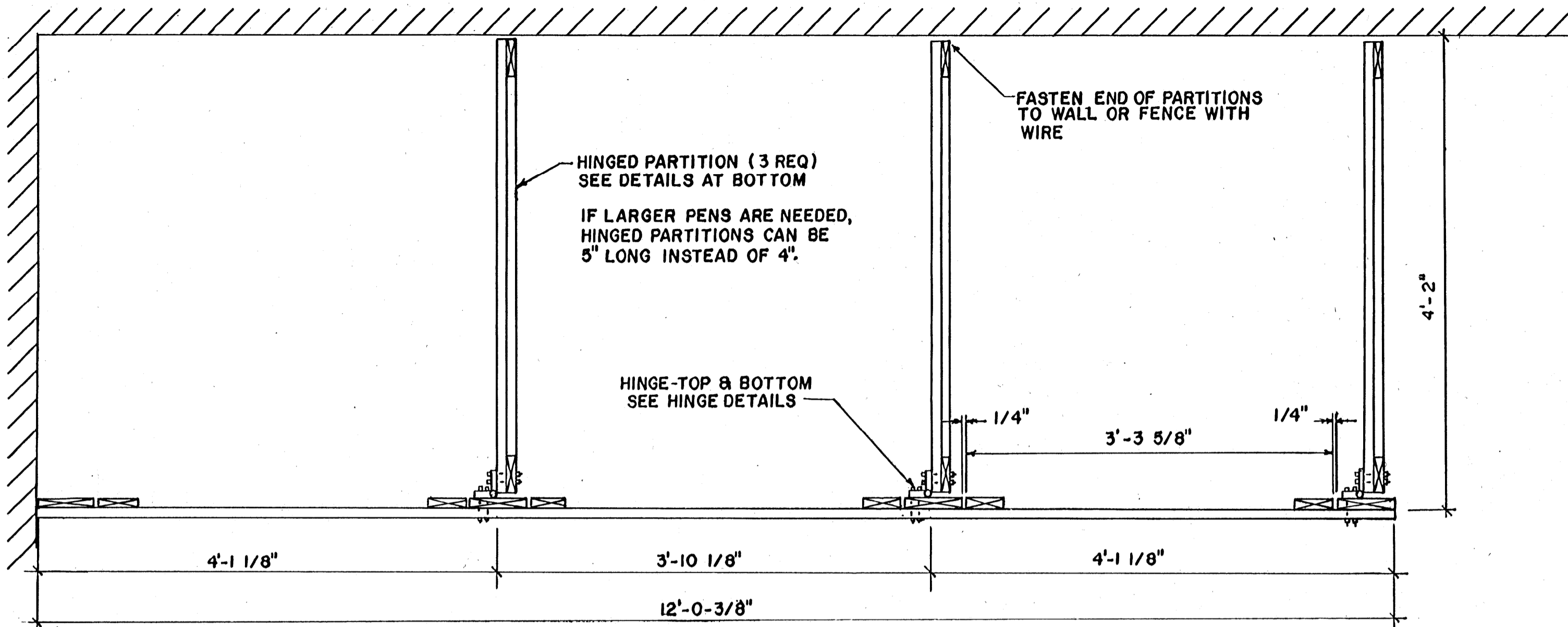

PLAN VIEW

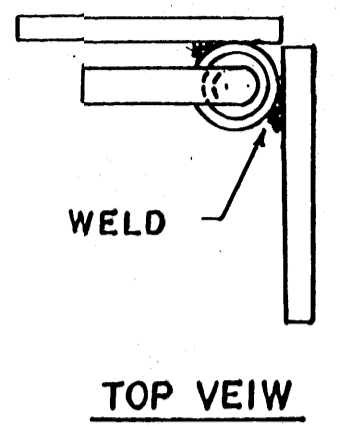

TOP VIEW

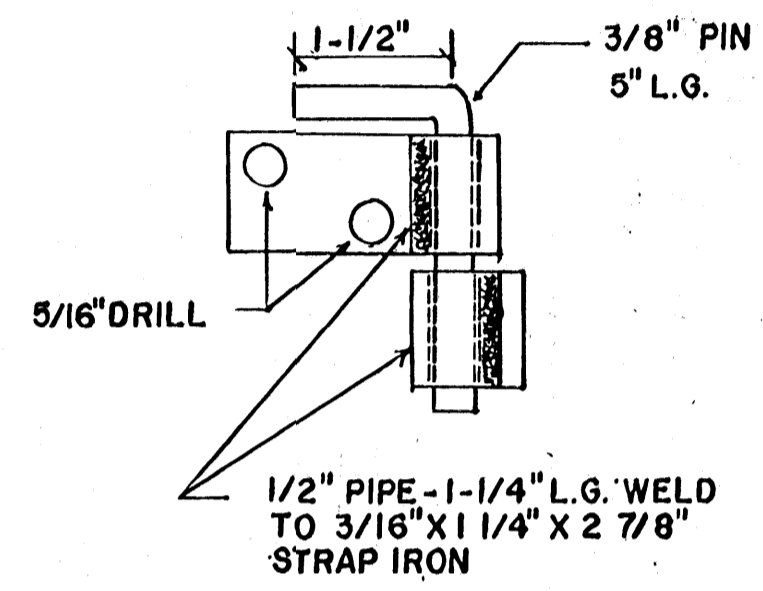

SIDE VIEW

HINGE DETAILS

SCALE: 1/2" = 1"

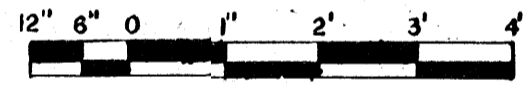

1/4" CARRIAGE BOLT W/HEX NUT & WASHER OR 1/4" MACHINE RIVETS W/WASHERS BOTH ENDS

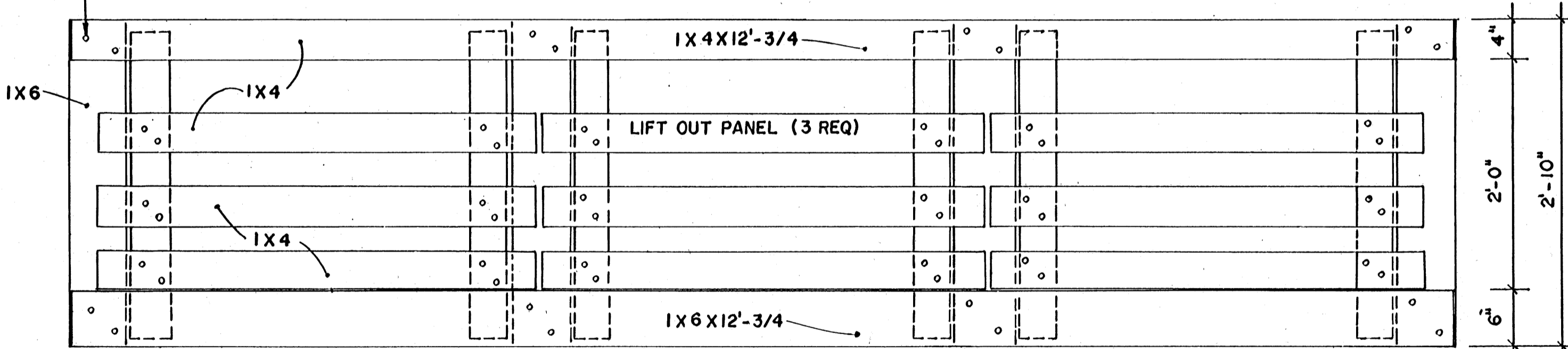

ELEVATION VIEW

NOTES

1. SIZES SHOWN ARE FOR FULL DIMENSION LUMBER
2. SURFACED LUMBER CAN BE USED OVERALL DIMENSIONS WILL BE THE SAME BUT SPACING BETWEEN SOME MEMBERS WILL BE DIFFERENT

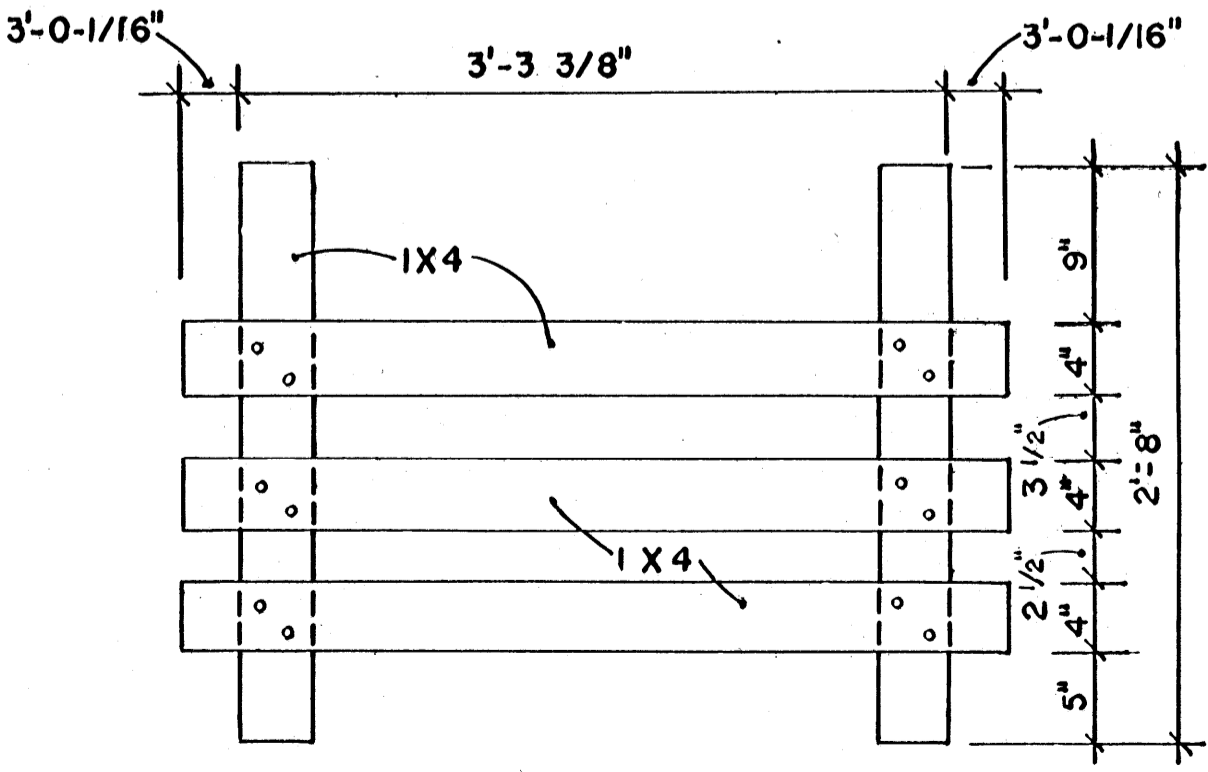

LIFT OUT PANEL DETAILS

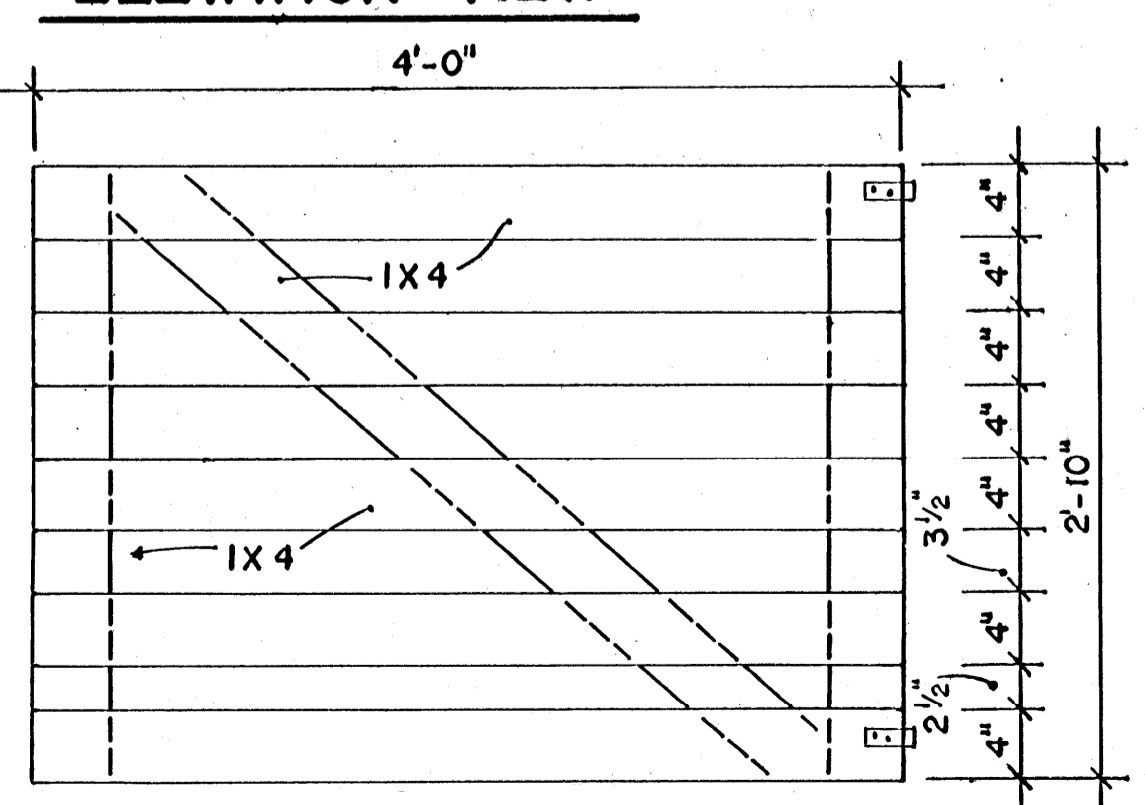

PARTITION DETAILS

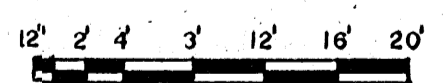

SCALE: 3/32" = 1" UNLESS OTHERWISE NOTED

COOPERATIVE EXTENSION WORK IN AGRICULTURE AND HOME ECONOMICS
AND UNITED STATES DEPARTMENT OF AGRICULTURE COOPERATING
PORTABLE LAMBING UNIT
W.V. '73 EX. 6304 SHEET 1 OF 1